



10

SINGLE & PARALLEL
AUTOCLAVABLE
FERMENTERS/
BIOREACTORS



SOLARIS
BIOTECH SOLUTIONS

SINGLE & PARALLEL MINI FERMENTERS/BIOREACTORS

10

IO, the smallest scale Solaris platform, offers 200 ml and 1000 ml total volume autoclavable vessel sizes. The system utilizes innovative Leonardo software, capable of managing up to 24 systems in parallel.



IO typical applications includes the following:
Education & Basic research
Scale-up and scale-down studies
Process development and optimization

IO can be used for:
Biopharmaceutical
Biofuels
Food industry
Bioremediation
Bioplastic
Cosmeceutical
Nutraceutical

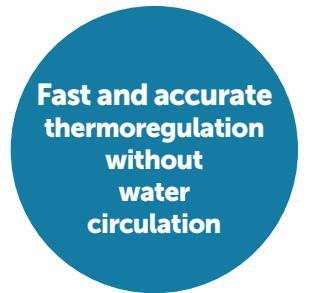

Benefits

Up to 24 units managed with one HMI with innovative PARALLEL process control
LEONARDO: smart controller designed to provide a high level of automated management of the fermentation/cultivation processes

Batch, Fed batch or continuous processes

Different gas mixing strategies with up to 5 TMFC

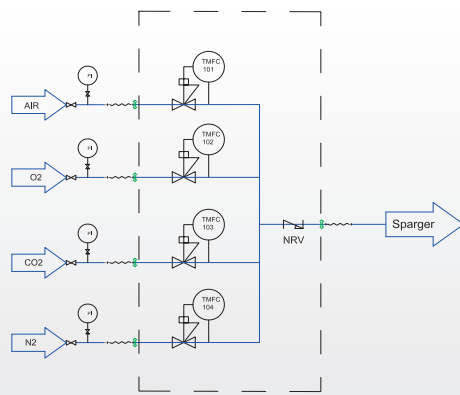

24" HMI

Remote control via PC, tablet and smartphone for process management and after sale assistance

Powerful/ Accurate **brushless motor**, from 1 to 2000 RPM. Online absorbed Torques (Nm) and Power (W) measurements obtaining an indirect density indication of the culture broth

Modbus Digital sensors



LEDA safe sterile sampling system
The needle free connector is designed to reduce the risk of contamination during sampling.
The sterile combination of a syringe (3-5-10-30 ml) and a non return valve guarantees the sterility after sampling until the next use.



No water circulation: Thermoregulation performed through Peltier cell



N.4 assignable Watson Marlow pumps in entry level

Compact and modular PCS

Additional parameter in modular external boxes for future PCS upgrade Including dCO₂, cell density, weight, peristaltic pumps, ect

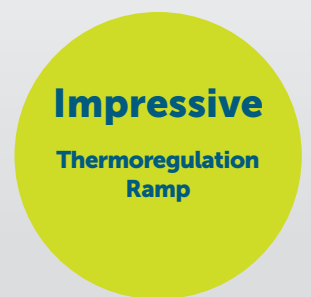
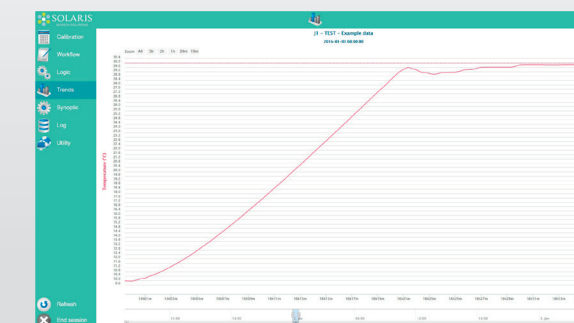

SINGLE & PARALLEL MINI FERMENTERS/BIOREACTORS

Modbus Digital sensors

Why a digital sensor?

Digital sensors (including Cell Density products) have been integrated to the Solaris PCS and Leonardo controlling software, giving the user many benefits over traditional analog sensor outputs. Such benefits include a robust communication protocol not susceptible to signal loss, in-software sensor diagnostic information, parallel calibration/batch calibrations and more.



Sensor life traceability

Reducing background noise

Smart PCS



Solaris new modular product design strategy decreases time to market and the number of unique parts in the product architecture, increasing the number of product variants. The result is a lean, flexible and smart PCS, which can be stacked in case of parallel processes through a dedicated support.

Optimize Lab Space!

Additional parameters in modular external boxes for future PCS upgrade including dCO₂, Cell Density, Weight, Peristaltic pumps, ect.



Leonardo 3.0

USER-FRIENDLY SOFTWARE

Solaris controlling software offers a simply laid out, yet powerful platform for experimental design planning and process control. The graphical user interface enables the intuitive selection and adjustment of control functions. Extracted data is compatible with Window Excel but, in addition, Solaris offers a platform where fermentation data can be easily exported in real time and thus managed. This software is included in the supply and can be installed on an unlimited number of the client's PC or laptops.

Do it parallel: smarter..faster



Leonardo allows intuitive and time-saving parallel operations. Up to 24 independent fermentations/cultivations can be carried out simultaneously.

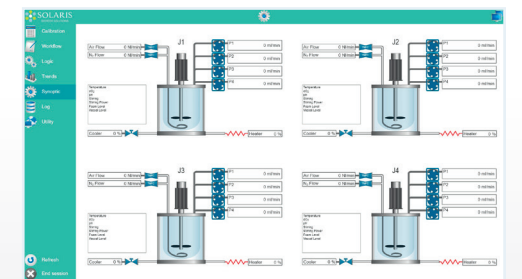

Parallel synoptic.

Do it wireless!



Increase mobility: users have the option to access the platform remotely, via PC, tablet, phone. Remote access is multi-level password protected.

Data sheet

Vessel		
Solaris Code	IO 200	IO 1000
Total Volume (ml)	200	1000
Ratio H/D	1:1,5	1:2,5
Min. Working Volume (ml)	120	250
Max. Working Volume (ml)	150	750
Max. temperature	70 °C	
Max Operating pressure	0,9 bar (g)	
Material	Borosilicate glass and AISI 316 L	
Headplate Ports (n.8 IO 200, N.10 IO 1000)	IO 200: n.3 PG13.5 (sensors, gas out condenser, multifeed), n.2 ports DN8 (gas in sparger, harvest/sampling), n.3 DN9 (gas out, antifoam probe, level probe, single feed) IO 1000: n.5 PG13.5 (sensors, gas out condenser, multifeed, level probe), n.5 ports DN9 (gas in sparger, harvest, sampling, gas out, antifoam probe, single feed)	
Sensors length (mm)		
length	120	225
Dimensions for autoclave (with condenser)		
Height (mm)	280	380
Diameter (mm)	170	150
Stirring		
Drive	Brushless Motor, 1-2000 rpm	
Power	100 W	
Impellers	Select from: Rushtons impellers, Marine Impellers, Pitched blade	
Thermoregulation		
Control	PID control - accuracy 0,1°C - Peltier Cell	
Gas Control & Gas Mixing		
Sparger and overlay Gas Control	TMFC	
Gas Mixing (Air,CO ₂ ,O ₂ ,N ₂)	1TMFC (included in entry level) +4 solenoid valves or + n. of additional TMFC	
Sparger type	Fluted with laser microholes provided with 0,2 µm filter	
Exhaust	0,2 µm filter	
Peristaltic Pumps		
	n.4 Watson Marlow type 114, fixed speed, max. 60 rpm, volumetric flow 0,5-51 ml/min, function assignable from software	
Controller		
PCS	from 1 to 24 units - H: 350mm L: 350mm D: 350mm	
HMI with Leonardo software	24"	

Controls

pH	
Sensor	Digital sensor
Sensitivity	57 to 59 mV/pH
Control system	Measuring resident in Leonardo 3.0 software
Control range	0 - 14
Operation temperature	0 - 130°C
Pressure range	0 - 6 bar
Actuator	Cascade to peristaltic pumps for the addition of acid/base solutions or gas (CO ₂)
dO ₂	
Sensor	Digital Optical sensor
Accuracy	±0.05%-vol, 21±0.2%-vol, 50±0.5%-vol
Control system	Measuring resident in Leonardo 3.0 software
Control range	0,05 - 300% air saturation
Operation temperature	-10 - 130°C
Pressure range	0 - 12 bar
Actuator	Cascade to RPM, Gas Control, feedings,ect
Redox (ORP)	
Sensor	Digital sensor
Sensitivity	57 to 59 mV/pH
Control system	Measuring resident in Leonardo 3.0 software
Operation temperature	- 10 -130°C
Pressure range	≤ 6 bar
Control range	±2000 mV
Antifoam/Level	
Sensor	Solaris sensor
Control	Measuring resident in Leonardo 3.0 software
Conductivity	
Sensor	Digital sensor
Accuracy	±3% at 1 µS/cm to 100 mS/cm, ± 5% at 100 to 300 mS/cm
Control system	Measuring resident in Leonardo 3.0 software
Operation temp	0 -130°C
Pressure range	0 - 20 bar
Control range	1 - 3000 µS/cm

dCO ₂	
Sensor	Analog sensor
Accuracy	±10% (pCO ₂ 10-900 mbar) ≥ ± 10%
Control system	Measuring resident in Leonardo 3.0 software
Operation temperature	-20.0-150°C
Control range	0 - 4 bar(g)
Cell density	
Sensor	Digital sensor
Accuracy	Mammalian cells in suspension ± 5·10 ⁴ cells/ml - Fermentation ± 0.05 g/l dry weight
Control system	Measuring resident in Leonardo 2.0 software
Option 1	Dencytee: Total cell density based on turbidity (10 ⁴ to 10 ⁸ mammalian cells/ml- 0.5 to 100 g/L dry weight)
Option 2	Incyte: Viable cell density based on capacitance (5x10 ⁴ to 8x10 ⁸ mammalian cells/ml-5 to 200 g/L dry weight)
Weight	
Sensor	Digital balance
Accuracy	±0.1 g
Control	Measuring resident in Leonardo 3.0 software
Peristaltic pumps	
WM 313 FDM/D	175 rpm

MODULAR EXTERNAL BOX

INTEGRATED IN THE PCS

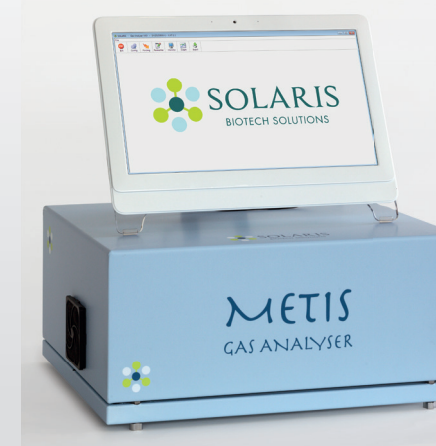

**UP TO 8
FERMENTERS
CONNECTED!**

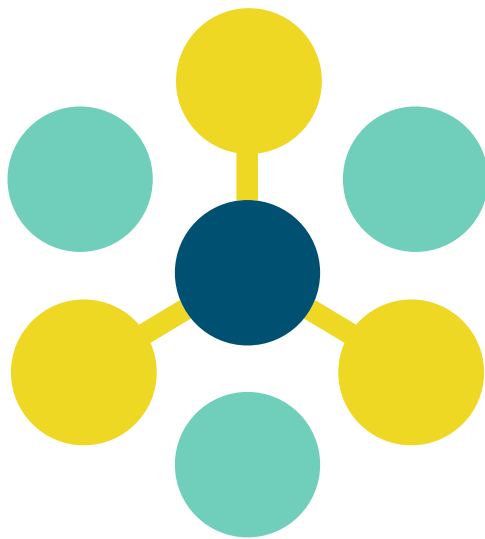

SOLARIS

BIOTECH SOLUTIONS

SOLARIS BIOTECHNOLOGY srl

Via Bachelet, 58 - 46047 Porto Mantovano

Mantova - Italy

Phone: +39 0376 408760

Fax: +39 0376 385108

Email: info@solarisbiotech.com

www.solarisbiotech.com