

English

OPERATING MANUAL

Immersion Coolers

FT402

FT902

FT903

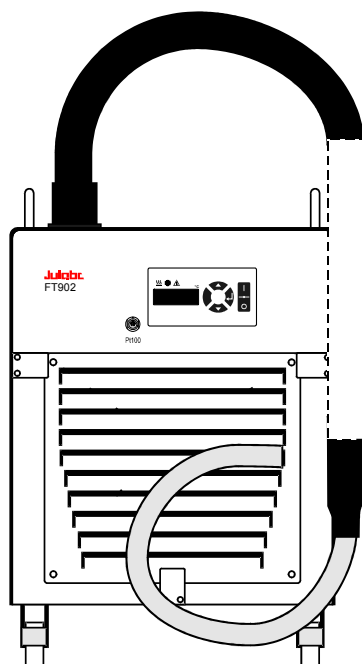

Julabo
THE TEMPERATURE CONTROL COMPANY

JULABO USA, Inc.
884 Marcon Boulevard
Allentown, PA 18109
Phone: +1(610) 231-0250
Fax: +1(610) 231-0260
info.us@julabo.com
www.julabo.com

Congratulations!

You have made an excellent choice.

JULABO thanks you for the trust you have placed in us.

This operating manual has been designed to help you gain an understanding of the operation and possible applications of our immersion coolers. For optimal utilization of all functions, we recommend that you thoroughly study this manual prior to beginning operation.

The JULABO Quality Management System



Temperature control devices for research and industry are developed, produced, and distributed according to the requirements of ISO 9001 and ISO 14001. Certificate Registration No. 01 100044846

Unpacking and inspecting

Unpack the immersion cooler and accessories and inspect them for possible transport damage. Damage should be reported to the responsible carrier, railway, or postal authority, and a damage report should be requested. These instructions must be followed fully for us to guarantee our full support of your claim for protecting against loss from concealed damage. The form required for filing such a claim will be provided by the carrier.

1.953.4620-V6 02/19 Printed in Germany Changes without prior notification reserved

Important: keep operating manual for future use

TABLE OF CONTENTS

Operating manual.....	4
1. Intended use	4
1.1. Description.....	4
2. Operator responsibility – Safety instructions	4
2.1. Disposal.....	6
2.2. Technical specifications	8
Operating instructions	11
3. Operating controls and functional elements.....	11
4. Safety notes for the user.....	13
4.1. Explanation of safety notes.....	13
4.2. Explanation of other notes	13
4.3. Safety instructions	14
5. Preparations.....	15
5.1. Installation.....	15
5.2. Immersion probe / Sensor connection - Pt100.....	16
6. Operating procedures	17
6.1. Power connection	17
6.2. Switching on / Start - Stop	17
6.3. Automatic / non-automatic start mode	18
6.4. Setting the temperatures.....	19
6.5. Temperature control.....	19
7. Troubleshooting guide / Error messages	20
8. Electrical connection	21
9. Cleaning / repairing the unit	22
10. WARRANTY PROVISIONS	24

Operating manual

1. Intended use

JULABO immersion coolers have been designed for temperature application to specific fluids in a bath tank.

For example: Dewar vessels, beakers, or other containers in conjunction with heating circulators for continuous countercooling or for dry-ice substitution.



JULABO immersion coolers are not suitable for direct temperature control of foods, semi-luxury foods and tobacco, or pharmaceutical and medical products. Direct temperature control means unprotected contact of the object with the bath medium (bath fluid).

1.1. Description



- ☑ The immersion coolers are operated via the keypad. The implemented microprocessor technology allows to set and to store the setpoint that can be indicated on the LED temperature display.

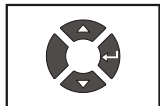

- ☑ The PID temperature control adapts the cooling supply to the thermal requirements of the bath.



- ☑ Electrical connection:
Connection for Pt100 external sensor for temperature measurement and control.

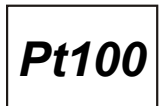

- ☑ Model FT402 is provided with a handle for portable use. The Models FT902, FT903 are equipped with four castors. Two of the castors include locking levers that should be pressed down after setting up the unit to prevent it from moving.



- ☑ The immersion probe is connected to the instrument with a flexible, specially insulated tube. On models FT902, FT903 the immersion probe is also flexible and may be adjusted precisely to different positions within the vessel.

2. Operator responsibility – Safety instructions

The products of JULABO ensure safe operation when installed, operated, and maintained according to common safety regulations. This section explains the potential dangers that may arise when operating the circulator and also specifies the most important safety precautions to preclude these dangers as far as possible.

The operator is responsible for the qualification of the personnel operating the units.

- The personnel operating the units should be regularly instructed about the dangers involved with their job activities as well as measures to avert these dangers.
- Make sure all persons tasked with operating, installing, and maintaining the unit have read and understand the safety information and operating instructions.

- When using hazardous materials or materials that could become hazardous, the circulator may be operated only by persons who are absolutely familiar with these materials and the circulator. These persons must be fully aware of possible risks.

If you have any questions concerning the operation of your unit or the information in this manual, please contact us!

Contact	JULABO USA, Inc. 884 Marcon Boulevard Allentown, PA 18109	Phone: +1(610) 231-0250 Fax: +1(610) 231-0260 info.us@julabo.com www.julabo.com
----------------	---	--

Safety instructions for the operator:

- Avoid strikes to the housing, vibrations, damage to the operating-element panel (keypad, display), and contamination.
- Make sure the product is checked for proper condition regularly (depending on the conditions of use). Regularly check (at least every 2 years) the proper condition of the mandatory, warning, prohibition and safety labels.
- Make sure that the mains power supply has low impedance to avoid any negative effects on the instruments being operated on the same mains.
- This unit is designed for operation in a controlled electromagnetic environment. This means that transmitting devices (e.g., cellular phones) should not be used in the immediate vicinity.
- Magnetic radiation may affect other devices with components sensitive to magnetic fields (e.g., monitors). We recommend maintaining a minimum distance of 1 m.
- Permissible ambient temperature: max. 35 °C, min. 5 °C.
- Permissible relative humidity: 50 % (35 °C).
- Do not store the unit in an aggressive atmosphere. Protect the unit from contamination.
- Do not expose the unit to sunlight.

Appropriate operation

Only qualified personnel is authorized to configure, install, maintain, or repair the circulator. Persons who operate the circulator must be trained in the particular tasks by qualified personnel. The summarized user guidance (short manual) and the specification table with information on individual parameters are sufficient for this.

Use

The bath can be filled with flammable materials. Fire hazard!

There might be chemical dangers depending on the bath medium used.



Observe all warnings for the used materials (bath fluids) and the respective instructions (safety data sheets).

Insufficient ventilation may result in the formation of explosive mixtures. Only use the unit in well ventilated areas.

Only use recommended materials (bath fluids). Only use non-acid and non corroding materials.

When using hazardous materials or materials that could become hazardous, **the operator must** affix the enclosed safety labels to the front of the unit so they are highly visible:

If this unit is intended for use within the United States of America, all 3 warning labels **must** be affixed to the housing of the unit prior to use. Directions for the positioning of the individual warning labels are enclosed with the warning labels included in the delivery. Warning labels must be easily visible to users.

1		Danger area. Attention! Observe instructions. (operating manual, safety data sheet)
2 or 2		Carefully read the user information prior to beginning operation. Scope: EU
2		Carefully read the user information prior to beginning operation. Scope: USA, NAFTA
3	<div style="border: 1px solid black; padding: 5px;"> <p>WARNING: This product contains chemicals known to the state of California to cause cancer, birth defects or other reproductive harm.</p> </div>	Warning label Proposition 65

Particular care and attention is necessary because of the wide operating range.

There are thermal dangers: Touchable parts of the probe can be very cold.

The user must attach the enclosed safety labels to the unit so they are easily visible.

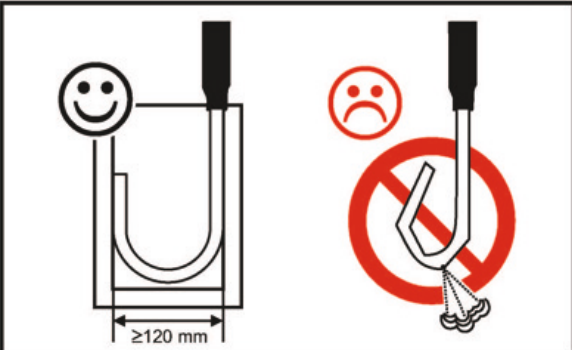

Attention:

- Note a minimum bending radius of the probe.
- Do not touch cold probe.

2.1. Disposal

The product may be used with oil as bath fluid. These oils fully or partially consist of mineral oil or synthetic oil. For disposal, follow the instructions in the material safety data sheets.

This unit contains refrigerants, which at this time are not considered harmful to the ozone layer. However, over the long operating period of the unit, disposal rules may change.

Therefore, only qualified personnel should handle the disposal.

2.2. Technical specifications

Immersion cooler		FT402
Working temperature range	°C	-40 ... 30
Temperature stability	°C	±0.5
Temperature selection		digital
Temperature indication		LED
Resolution	°C	0.1
Temperature control		PID1
Cooling capacity	°C	<u>+20 10 -20 -40</u>
Medium ethanol	kW	0.45 0.36 0.14 0.03
Cooling compressor		1-stage
Refrigerant	230 V / 50 Hz 115 V / 60 Hz	R452A R404A
Electrical connections:		
Pt100 external sensor		Pt100
Overall dimensions (WxDxH)	cm	20x30x43
Immersion probe (Lxdia.)	cm	12x5
Immersion probe, flexible (Lxdia.)	cm	-----
Connection tubing (L)	cm	120
Noise level, distance 1 m	dBA	61
Weight	kg	24
Ambient temperature	°C	5 ... 35 (32 with R452A)
Mains power connection	V/ Hz	230 / 50- 60
Current input (at 230 V)	A	3
Mains power connection	V/ Hz	115 / 60
Current input (at 115 V)	A	4

All measurements have been carried out at: rated voltage and frequency
 ambient temperature: 20 °C Technical changes without prior notification reserved.

Immersion cooler		FT902			FT903		
Working temperature range	°C	-90 ... 30					
Temperature stability	°C	±1					
Temperature selection		digital					
Temperature indication		LED					
Resolution	°C	0.1					
Temperature control		PID1					
Cooling capacity FT903	°C	20	10	0	-10	-20	-30
(Medium ethanol)	kW	0.3	0.29	0.27	0.26	0.25	0.24
Cooling capacity FT903	°C	-40	-50	-60	-70	-80	
(Medium ethanol)	kW	0.23	0.21	0.18	0.13	0.05	
Cooling capacity FT902	°C	20	10	-20	-40	-80	
(Medium ethanol)	kW	0.3	0.27	0.24	0.2	0.07	
Cooling compressor		2-stage					
Refrigerant 230 V / 50 Hz 115 V / 60 Hz		R404A/R23 R404A/R23					
Electrical connections:							
Pt100 external sensor		Pt100					
Overall dimensions (WxDxH)	cm	38x55x60					
Immersion probe (Lxdia.)	cm	-----			see dimensions page 18		
Immersion probe, flexible (Lxdia.)	cm	65x1.5					
Connection tubing (L)	cm	160					
Noise level, distance 1 m	dBA	60					
Weight	kg	50			50		
Ambient temperature	°C	5 ... 35			5 ... 40		
Mains power connection	V/ Hz	230 ±10 % / 50/60					
Current input	A	6			6		
Mains power connection	V/ Hz	115 / 60			-		
Current input	A	12			-		

All measurements have been carried out at: rated voltage and frequency
 ambient temperature: 20 °C Technical changes without prior notification reserved.

Operating instructions

3. Operating controls and functional elements

FT402 Front view

Rear view

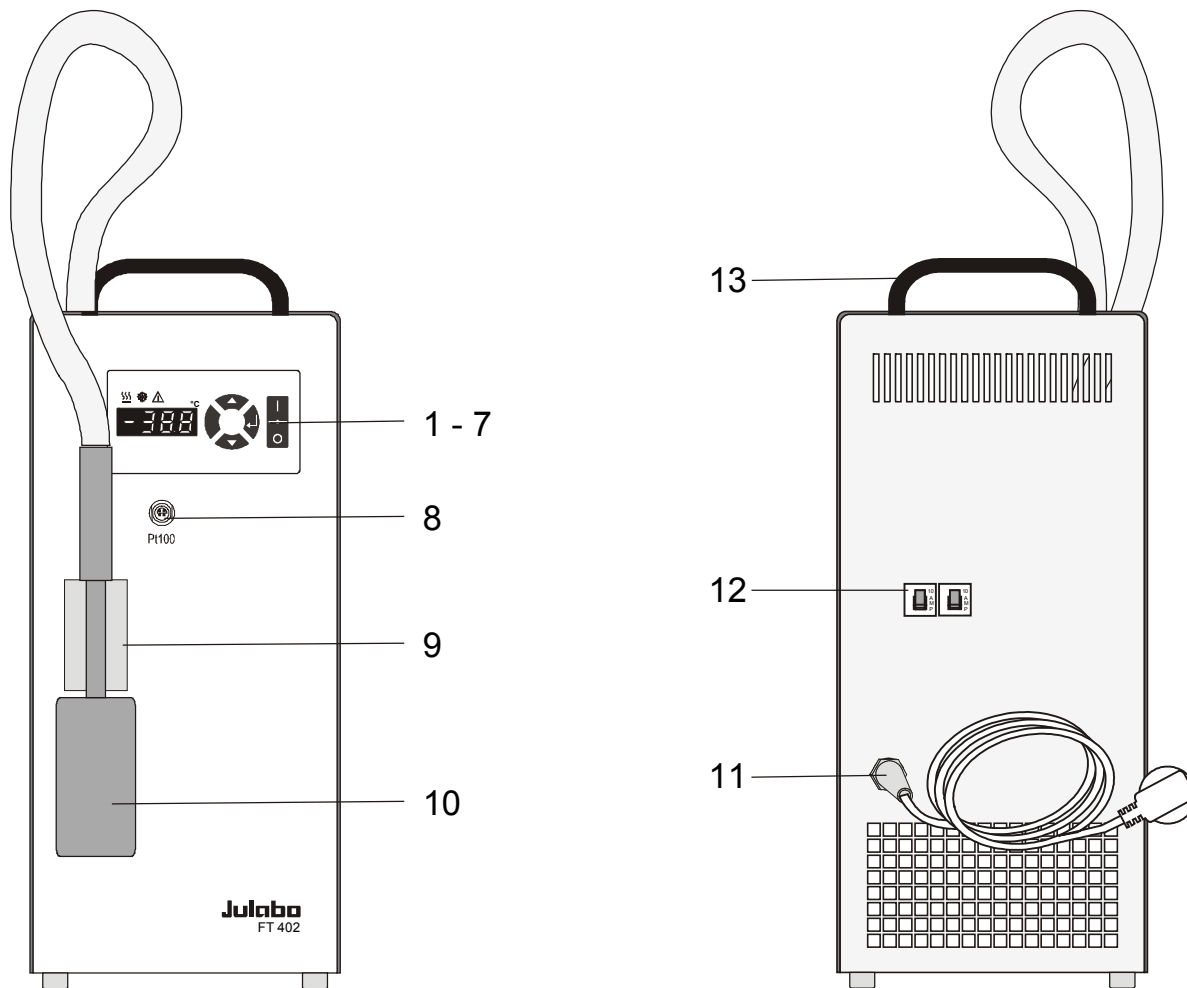

- | | | |
|---|--|--|
| 1 | | Mains power switch, illuminated
I on
O off |
| 2 | | Edit keys (increase/decrease setting) |
| 3 | | Enter key (store) |
| 4 | | LED temperature display |
| 5 | | Control indicator – Heating (without function) |
| 6 | | Control indicator – Cooling |
| 7 | | Control indicator – Alarm |

Operating controls and functional elements

FT902, FT903

Front view

Rear view

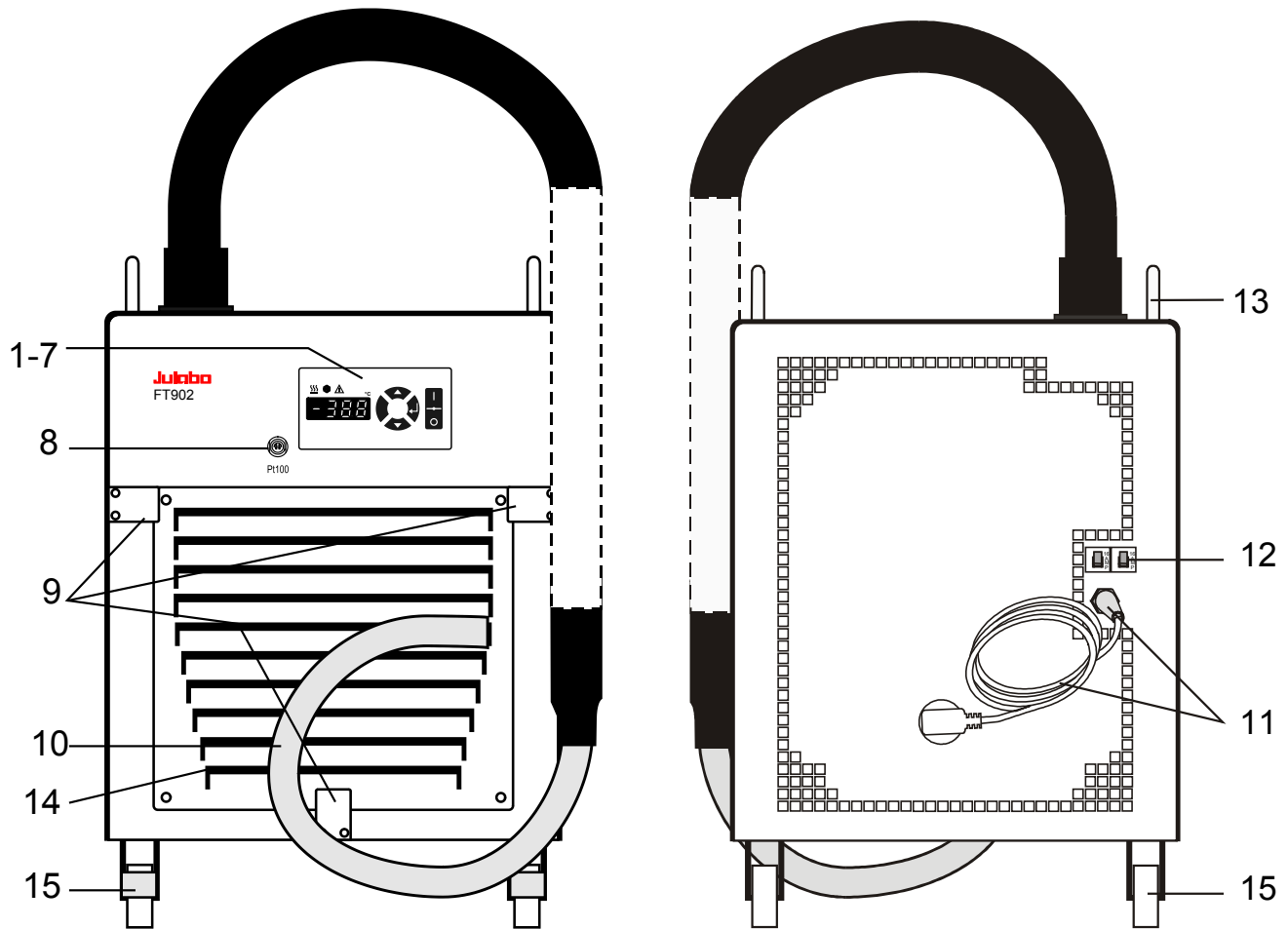

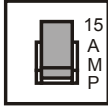
- 8  External Pt100 sensor connector
Included with each unit:
Order No. 8 981 003
Pt100 sensor, 200x6 mm dia., stainless steel
- 9 Clamp for immersion probe
- 10 Immersion probe
- 11 Mains power cable with plug
- 12  Mains circuit breakers (resettable)
FT402 10 A FT902, FT903 15 A
- 13 Carrying handle
- 14 Venting grid, removable (only FT902, FT903)
- 15 Castor with brake (at the front)
Castor without brake (at the back)

3.1. Dimensions of the FT903 probe (in mm)

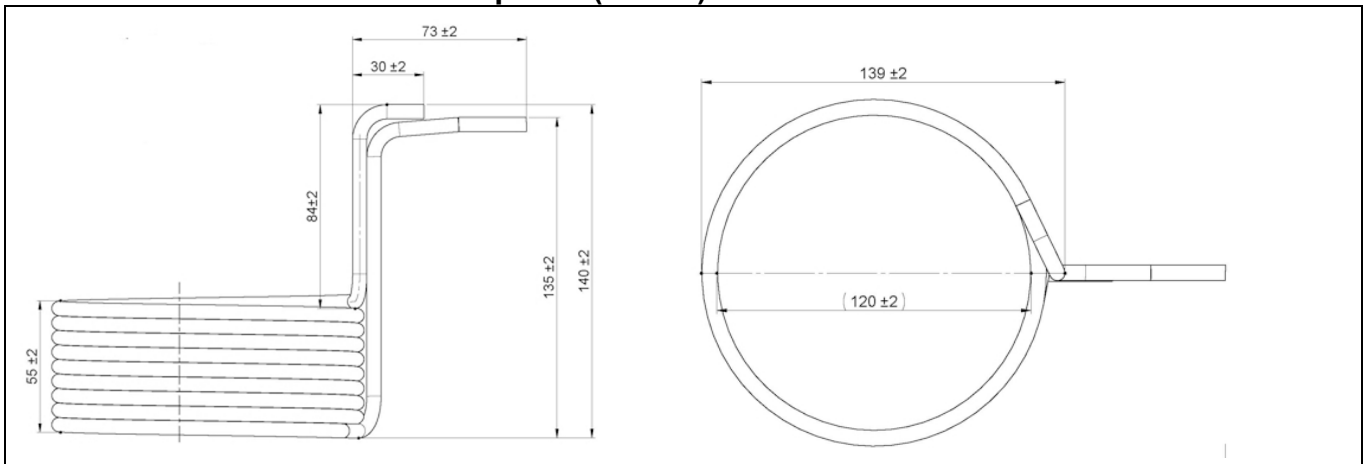

4. Safety notes for the user

4.1. Explanation of safety notes



In addition to the safety warnings listed above, warnings are posted throughout the manual. These warnings are designated by an exclamation mark inside an equilateral triangle. “Warning of a dangerous situation (Attention! Please follow the documentation).”

The danger is classified using a signal word.
Read and follow these important instructions.



Warning:

Describes a possibly highly dangerous situation. If these instructions are not followed, serious injury and danger to life could result.



Caution:

Describes a possibly dangerous situation. If this is not avoided, slight or minor injuries could result. A warning of possible property damage may also be contained in the text.



Notice:

Describes a possibly harmful situation. If this is not avoided, the product or anything in its surroundings can be damaged.

4.2. Explanation of other notes



Note!

Draws attention to something special.



Important!

Indicates usage tips and other useful information.

4.3. Safety instructions

Follow the safety instructions to avoid personal injury and property damage. Also, the valid safety instructions for workplaces must be followed.



- Only connect the unit to a power socket with an earthing contact (PE – protective earth)!
- The power supply plug serves as a safe disconnecting device from the line and must always be easily accessible.
- Place the unit on an even surface on a base made of nonflammable material.
- Do not stay in the area below the unit.
- Make sure you read and understand all instructions and safety precautions listed in this manual before installing or operating your unit.
- Do not touch the immersion probe if it is frosted.
- Do not bend the tube connection of the immersion probe
- Keep the air intake and exhaust grids free of obstructions. (Maintain a sufficient distance from all surrounding surfaces!)
- Do not move the unit from the position where it was set up during operation.
- Always turn off the unit and disconnect the mains cable from the power source before performing any service or maintenance procedures, or before moving the unit.
- Always turn off the unit and disconnect the mains cable from the power source before cleaning the unit.
- Transport the unit with care.
- Sudden jolts or drops may cause damage in the interior of the unit.
- Observe all warning labels.
- Never remove warning labels.
- Never operate units with damaged mains power cables.
- Repairs are to be carried out only by qualified service personnel.



- There are thermal dangers: Touchable parts of the probe can be very cold. Therefore, exercise particular caution when touching these parts. Use gloves.



WARNING

This product contains chemicals known to the state of California to cause cancer, birth defects or other reproductive harm.

5. Preparations

5.1. Installation

- Place the unit on an even surface on a pad made of non-flammable material.
- Press down the castor levers on models FT902, FT903.
- The place of installation should be large enough and provide sufficient air ventilation to ensure the room does not warm up excessively because of the heat the instrument rejects to the environment. For a fault (leakage) in the refrigeration system, the standard EN 378 prescribes a certain room space to be available for each kg of refrigerant.

> For 0.52 kg of refrigerant R404A, 1 m³ of space is required.

> For 0.423 kg of refrigerant R452A, 1 m³ of space is required.

> For 0.68 kg of refrigerant R23, 1 m³ of space is required.

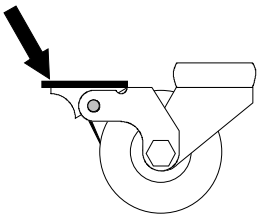

- The instrument should be set up at a frost-proof and dry location.
- The ambient temperature must not exceed 35 °C (32 °C at units with R452A).
- Keep at least 20 cm of open space on the front and rear venting grids.
- Do not set up the unit in the immediate vicinity of heat sources and do not expose to sun light.
- Before operating the unit after transport, **wait about one hour after setting it up**. This will allow any oil that has accumulated laterally during transport to flow back down thus ensuring maximum cooling performance of the compressor.

5.2. Immersion probe / Sensor connection - Pt100



Caution:

Avoid touching the immersion probe if it is frosted.

DANGER OF INJURY. Use gloves.

Switch the unit on only if the probe is immersed into the bath fluid.



Pt100

The immersion coolers are provided with a Pt100 sensor 200x6 mm dia., stainless steel - Order No. 8 981 003

- Connect the Pt100 sensor to the connector (Pt100) .
- To prevent the immersion probe (A) from icing, it should be completely immersed into the bath liquid (B).

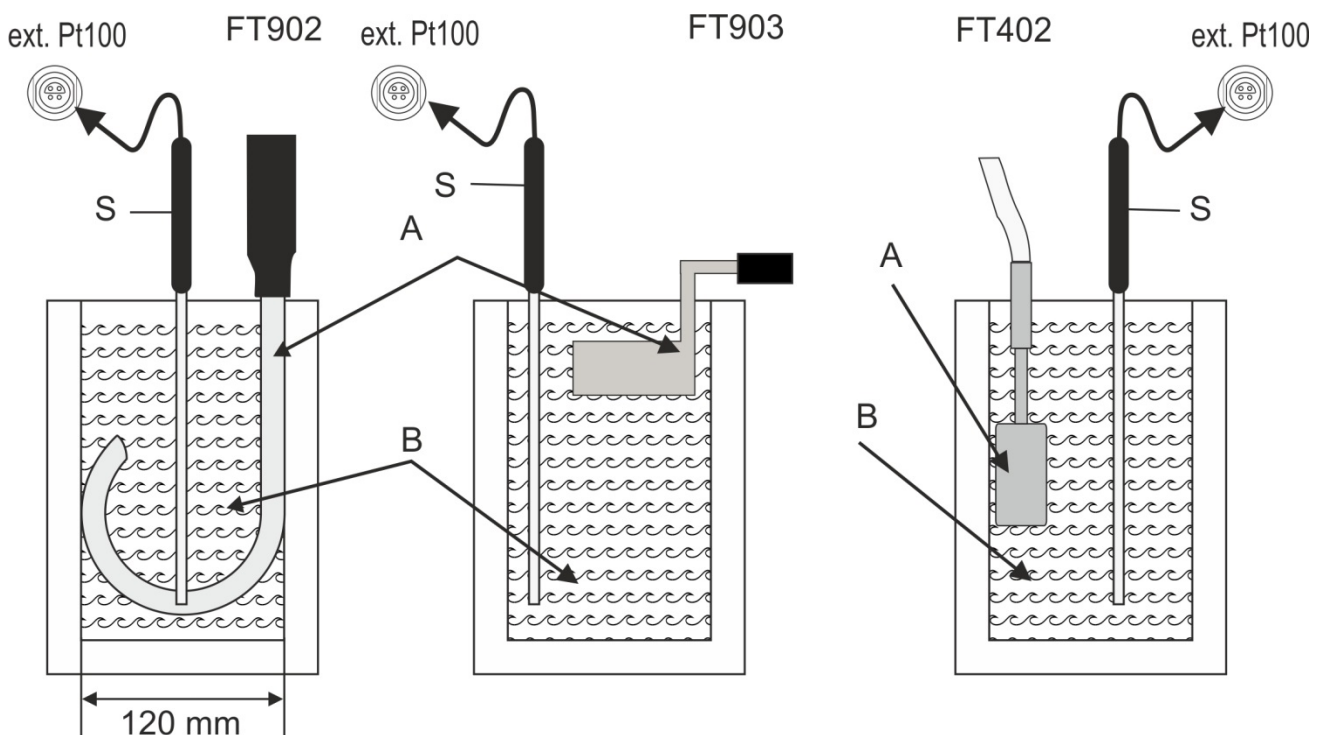

Important:

- ① Place the external sensor (S) into the bath medium and securely fix the sensor.
- ① FT902: The diameter of the bent probe should not be less than 120 mm.

Accessories:

Order No.	Description
8 981 005	Pt100 sensor 200x6 mm dia., glass, 1.5 m cable
8 981 010	Pt100 Fühler 300x6 mm dia., stainless steel, 1.5 m cable
8 970 400	Clamp for cooler probe FT402

6. Operating procedures

6.1. Power connection



Caution:

- Only connect the unit to a power socket with earthing contact (PE – protective earth)!
 - The power supply plug serves as safe disconnecting device from the line and must be always easily accessible.
 - Never operate equipment with damaged mains power cables.
 - Regularly check the mains power cables for material defects (e.g. for cracks).
- We disclaim all liability for damage caused by incorrect line voltages!

Make sure that the line voltage and frequency match the supply voltage specified on the type plate.
Deviations of $\pm 10\%$ are permissible.

6.2. Switching on / Start - Stop

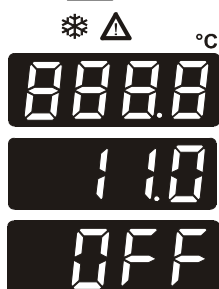
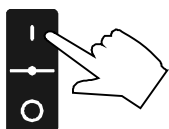

• **Switching on:**

The immersion cooler is turned on and off with the mains switch. (1).

- ① The unit performs a self-test. All segments of the 4-digit LED temperature DISPLAY and all indicator lights will illuminate (as illustrated on the left).
Then the software version (example: 11.0) appears.
The display "OFF" indicates the unit is ready to operate (standby mode).

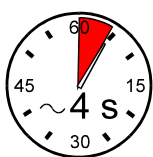

Start / Stop:

- Press enter for about 4 seconds.
- ① **Start:** The LED temperature DISPLAY indicates the actual bath temperature.
The cooling control indicator signals the cooling condition – on/off.
- ① **Stop:** The LED temperature DISPLAY indicates "OFF".
- **Switching off:**
Turn the unit off with the mains power switch.

6.3. Automatic / non-automatic start mode



- 1 Keep depressed enter  and
- 2 turn on the immersion cooler with the mains power switch.

For a short while the LED temperature DISPLAY indicates the effective start mode:

⇒ AUTOSTART on.

⇒ AUTOSTART off.

NOTE:

The immersion cooler has been configured and delivered by JULABO according to N.A.M.U.R. recommendations. This means for the start mode, that the unit must enter a safe operating state after a power failure (non-automatic start mode). This safe operating state is indicated by „OFF“ on the LED temperature display. A complete shutdown of the main functional elements is effected simultaneously. The values set on the immersion cooler remain stored, and the unit is returned to operation by pressing the start/stop key.

Should such a safety standard not be required, the AUTOSTART function (automatic start mode) may be activated, thus allowing the unit to be started directly by pressing the mains power switch or using a timer.



Warning:

For supervised or unsupervised operation with the AUTOSTART function, avoid any hazardous situation to persons or property.

The instrument no longer conforms to N.A.M.U.R. recommendations.

6.4. Setting the temperatures

This function is used to set the lowest desired temperature value.

① Setting can be carried out in the start/stop condition.

1. Press one of the keys ▼ ▲ for a short moment. The setpoint value instead of the actual value is indicated on the display for about 8 seconds. The value can now be changed.
2. Change value:
 - Press ▲ to set a higher value.
 - Press ▼ to set a lower value.
 - Keep the keys depressed for the value to change fast.
3. Press enter ↵ to store the value.

6.5. Temperature control

The immersion cooler can only control the temperature if both - the Pt100 sensor and immersion probe - are immersed into the same bath fluid.

Application: Cooling a fluid in a vessel

If the actual temperature falls below the setpoint temperature, the compressor is switched off (on FT902, FT903: only one of the two compressors).

The cooling control indicator ❄️ goes out. If cooling is required again, the compressor switches on automatically.

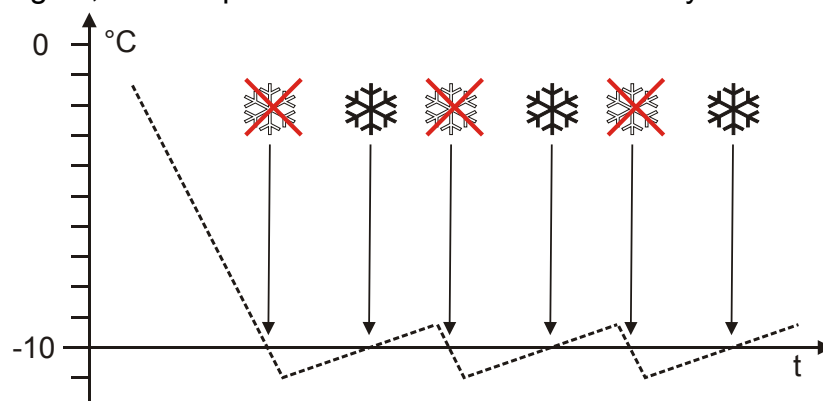

Example: Setpoint temperature $-10\text{ }^{\circ}\text{C}$

The temperature curve resembles a two-point control (on-off). Response time and amplitude of the temperature curve are depending on the volume of the bath fluid (amongst others).

① According to manufacturer's instructions, there is an off-period of minimum 4 minutes to protect the compressor.



Caution:

The immersion probe – as part of the cooling circuit – should not be exposed to bath temperatures above the working temperature of the immersion cooler. This would cause damage to the compressor. Do not immerse a frosted immersion probe into hot bath oil. DANGER OF INJURY!

7. Troubleshooting guide / Error messages



Whenever the microprocessor electronics registers a failure, a complete shutdown of the compressor is performed.

The alarm light "⚠" illuminates and a continuous signal tone sounds. The LED temperature display indicates the cause for the alarm in form of a code.



Press enter  to quit the audible signal.



- Cable of the working temperature sensor interrupted or short-circuited.
- The temperature inside the bath is outside the working temperature range.

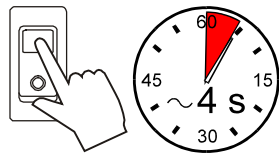

After eliminating the malfunction, press the mains power switch off and on again to cancel the alarm state. If the unit cannot be returned to operation, contact an authorized JULABO service station.

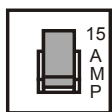

Mains circuit breakers (resettable)
FT402 10 A
FT902, FT903 15 A

8. Electrical connection



Notice:

Use shielded cables only.
 The shield of the connecting cable is electrically connected to the plug housing.

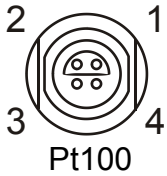

Connector for external Pt100 sensor

Pin assignment:

Pin	Signal
1	I+
2	U+
3	U-
4	I-

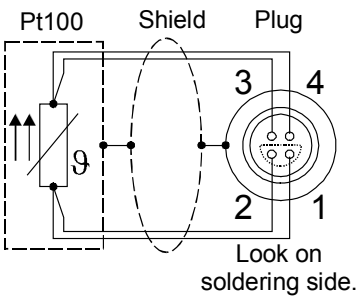

The shield of the connecting cable is electrically connected to the plug housing and the sensor tube.

9. Cleaning / repairing the unit



Caution:

Before cleaning the unit, disconnect the power plug from the mains socket!
Always turn off the unit and disconnect the mains cable from the power source before performing any service or maintenance procedures.
Service and repair work may be performed only by authorized electricians.
Prevent humidity from entering into the immersion cooler.

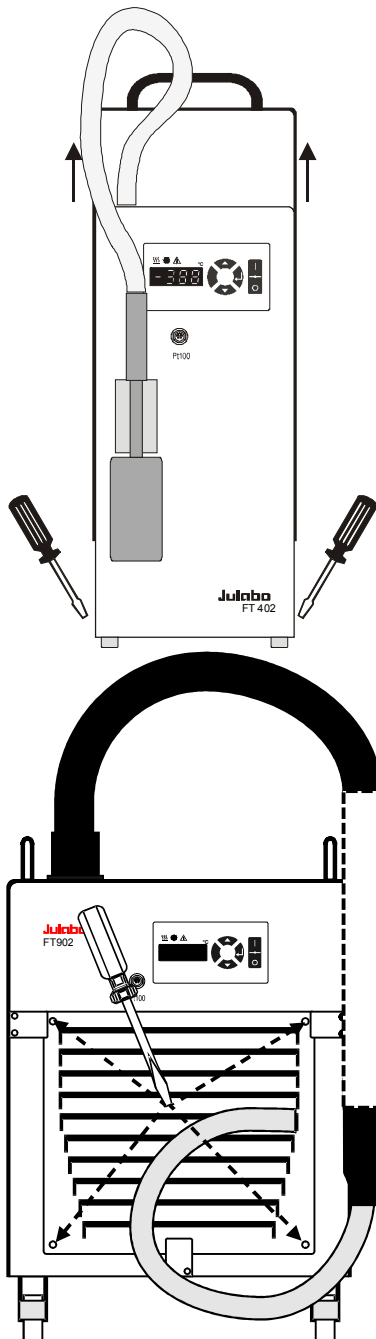

The immersion cooler is designed for continuous operation under normal conditions.
Periodic maintenance is not required.

- Clean the outside of the unit using a wet cloth and low surface tension water.

Regularly check the condenser for dirt contamination. Clean the ribbed condenser, because dust and dirt will reduce cooling performance of the unit.

Cleaning the Cooling Compressor:

- Switch off the unit, disconnect mains power cable.
- Model FT402: Remove the hood.
- Model FT902: The ventilation grid is detached by unscrewing the four mounting screws
- Clean the ribbed condenser with a vacuum cleaner.
- Replace the hood or the ventilation grid.
- Switch on the unit.

Repairs

Before asking for a service technician or returning a JULABO instrument for repair, please contact an authorized JULABO service station.

When returning the unit:

- Clean the unit in order to avoid any harm to the service personnel.
- Attach a short fault description.
- During transport the unit has to stand upright. Mark the packing correspondingly.
- When returning a unit, take care of careful and adequate packing.
- JULABO is not responsible for damages that might occur from insufficient packing.

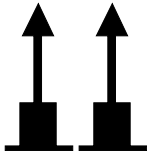

JULABO reserves the right to carry out technical modifications with repairs for providing improved performance of a unit.

10. WARRANTY PROVISIONS

The following Warranty Provisions shall apply to products sold in North America by Julabo (“**Seller**”) to the entity shown as buyer (“**Buyer**”) on Seller’s invoice.

1. **Initial Warranty.** Upon Seller’s receipt of payment in full for the products and subject to Buyer’s compliance with the terms of sale and any other agreement with Seller relating to the products, Seller warrants to the Buyer that the products manufactured by the Seller are free from defects in material and workmanship for a period not to exceed two (2) years or ten thousand (10,000) hours of operation, whichever comes first, from the date the product is shipped by Seller to Buyer (the “**Initial Warranty**”).

2. **EXCLUSION OF ALL OTHER EXPRESS WARRANTIES; EXCLUSION OF ALL IMPLIED WARRANTIES.** OTHER THAN THE INITIAL WARRANTY, NO OTHER EXPRESS WARRANTIES ARE MADE. ALL IMPLIED WARRANTIES OF EVERY TYPE AND KIND, INCLUDING BUT NOT LIMITED TO ANY IMPLIED WARRANTY OF MERCHANTABILITY OR FITNESS FOR A PARTICULAR PURPOSE OR USE, ARE EXCLUDED IN ALL RESPECTS AND FOR ALL PURPOSES. SELLER DISCLAIMS AND MAKES NO IMPLIED WARRANTIES WHATSOEVER.

3. **Exclusions.** The Initial Warranty does not include damage to the product resulting from accident, misuse, improper installation or operation, unauthorized or improper repair, replacement or alteration (including but not limited to repairs, replacements, or alterations made or performed by persons other than Seller’s employees or authorized representatives), failure to provide or use of improper maintenance, unreasonable use or abuse of the product, or failure to follow written installation or operating instructions. Buyer must return the product’s record of purchase to the Seller or one of Seller’s authorized representatives within thirty (30) days of the date the product is shipped by Seller to Buyer in order to make a claim under the Initial Warranty. Notwithstanding anything contained herein to the contrary, all glassware, including but not limited to reference thermometers, are expressly excluded from the Initial Warranty.

4. **Buyer’s sole remedies; Limitations on Seller’s Liability.** Buyer’s sole and exclusive remedy under the Initial Warranty is strictly limited, in Seller’s sole discretion, to either: (i) repairing defective parts; or (ii) replacing defective parts. In either case, the warranty period for the product receiving a repaired or replaced part pursuant to the terms of the Initial Warranty shall not be extended. All repairs or replacements performed by Seller pursuant to these Warranty Provisions shall be performed at Seller’s facility in Allentown, Pennsylvania, U.S.A. at the facility of an authorized representative of Seller, which location shall be determined by Seller in its sole discretion; provided, however, that Seller may, in its sole discretion perform such repairs or replacements at Buyer’s facility in which case Buyer shall pay Seller’s travel, living and related expenses incurred by Seller in performing the repairs or replacements at Buyer’s facility. As a condition precedent to Seller’s obligation to repair or replace a product part under the Initial Warranty, Buyer shall (i) promptly notify Seller in writing of any such defect; (ii) shall have returned the product’s record of purchase to Seller or to one of Seller’s authorized representatives within thirty (30) days of the date the product is delivered to Buyer; and (iii) assist Seller in all respects in its attempts to determine the legitimacy and basis of any claims made by or on behalf of Buyer including but not limited to providing Seller with access to the product to check operating conditions. If Buyer does not provide such written notice to Seller within the Initial Warranty period or fails to return the product’s record of purchase as set forth above, Seller shall have no further liability or obligation to Buyer therefore. In no event shall Seller’s liability under the Initial Warranty exceed the original purchase price of the product which is the subject of the alleged defect.

5. **THE REMEDIES PROVIDED IN THE INITIAL WARRANTY ARE THE SOLE AND EXCLUSIVE REMEDIES AVAILABLE TO THE BUYER. NOTWITHSTANDING ANYTHING TO THE CONTRARY CONTAINED HEREIN, AND EVEN IF THE SOLE AND EXCLUSIVE REMEDIES FAIL OF THEIR ESSENTIAL PURPOSE FOR ANY REASON WHATSOEVER, IN NO EVENT SHALL SELLER BE LIABLE FOR BUYER'S MANUFACTURING COSTS, LOST PROFITS, GOODWILL, OR ANY OTHER SPECIAL, INDIRECT, PUNITIVE, INCIDENTAL OR CONSEQUENTIAL DAMAGES TO BUYER OR ANY THIRD PARTY AND ALL SUCH DAMAGES ARE HEREBY DISCLAIMED.**

6. **Assignment.** Buyer shall not assign any of its rights or obligations hereunder without the prior written approval of Seller; provided, however, that if Buyer is a distributor of Seller, the rights and obligations of Buyer under these Warranty Provisions shall inure to the benefit of and be binding upon Buyer's customers who provide the product's proof of purchase to Seller pursuant to the terms set forth herein. Seller may assign any or all of its rights or obligations hereunder without Buyer's prior consent.

7. **Governing Law.** The Warranty Provisions and all questions relating to their validity, interpretation, performance, and enforcement shall be construed in accordance with, and shall be governed by, the substantive laws of the Commonwealth of Pennsylvania without regard to its principles of conflicts of law.

8. **Waiver.** Any failure of the part of Seller to insist on strict compliance with the Warranty Provisions shall no way constitute a waiver of such right. No claim or rights arising out of a breach of the Warranty Provisions by Buyer may be discharged in whole or in part by a waiver of the claim or right, unless the waiver is in writing signed by an authorized representative of Seller. Seller's waiver or acceptance of any breach by Buyer of any provisions of the Warranty Provisions shall not constitute a waiver of or an excuse for nonperformance as to any other provision of the Warranty Provisions nor as to any prior or subsequent breach of the same provision.

9. **Freight.** Buyer will arrange and pay for shipping and handling charges for the unit to be returned to the Seller. Seller will arrange and pay for shipping and handling for the return of the unit to the Buyer.